

Fassa S.r.l.

Via Lazzaris, 3
31027 Spresiano (TV)
Italy

Tel: +39 (0) 4227222 Fax: +39 (0) 422887509

e-mail: fassa@fassabortolo.it

website: www.fassabortolo.it



Agrément Certificate

14/5091

Product Sheet 1

FASSATHERM EXTERNAL WALL INSULATION SYSTEMS

FASSATHERM BONDED EPS EXTERNAL WALL INSULATION SYSTEMS

This Agrément Certificate Product Sheet⁽¹⁾ relates to Fassatherm Bonded EPS External Wall Insulation Systems, comprising white or grey expanded polystyrene (EPS) insulation boards, adhesively fixed with supplementary mechanical fixings, with a reinforced basecoat, primer and render finishes. They are suitable for use, with height restriction, on the outside of external walls in new and existing domestic and non-domestic buildings.

(1) Hereinafter referred to as 'Certificate'.

CERTIFICATION INCLUDES:

- factors relating to compliance with Building Regulations where applicable
- factors relating to additional non-regulatory information where applicable
- independently verified technical specification
- assessment criteria and technical investigations
- design considerations
- installation guidance
- regular surveillance of production
- formal three-yearly review.

KEY FACTORS ASSESSED

Thermal performance — the systems can be used to improve the thermal performance of external walls and can contribute to satisfying the requirements of the national Building Regulations (see section 6).

Strength and stability — the systems can adequately resist wind loads and have sufficient resistance to impact damage (see section 7).

Behaviour in relation to fire — the systems have a reaction to fire classification of B-s2, d0 in accordance with BS EN 13501-1 : 2007 and their use is restricted (see section 8).

Risk of condensation — the systems can contribute to limiting the risk of interstitial and surface condensation (see section 11).

Durability — when installed and maintained in accordance with the Certificate holder's recommendations and the terms of this Certificate, the systems will remain effective for at least 30 years (see section 13).

The BBA has awarded this Certificate to the company named above for the systems described herein. These systems have been assessed by the BBA as being fit for their intended use provided they are installed, used and maintained as set out in this Certificate.

On behalf of the British Board of Agrément

John Albon – Head of Approvals
Construction Products

Claire Curtis-Thomas
Chief Executive

Date of Third issue: 21 August 2018

Originally certificated on 11 February 2014

Certificate amended on 3 September 2019 to include new regulatory guidance for fire in Scotland.

The BBA is a UKAS accredited certification body – Number 113.

*The schedule of the current scope of accreditation for product certification is available in pdf format via the UKAS link on the BBA website at www.bbacerts.co.uk
Readers MUST check the validity and latest issue number of this Agrément Certificate by either referring to the BBA website or contacting the BBA directly.*

Any photographs are for illustrative purposes only, do not constitute advice and should not be relied upon.



British Board of Agrément

Bucknalls Lane
Watford
Herts WD25 9BA

©2018

tel: 01923 665300
clientservices@bbacerts.co.uk
www.bbacerts.co.uk

Regulations

In the opinion of the BBA, Fassatherm Bonded EPS External Wall Insulation Systems, if installed, used and maintained in accordance with this Certificate, can satisfy or contribute to satisfying the relevant requirements of the following Building Regulations (the presence of a UK map indicates that the subject is related to the Building Regulations in the region or regions of the UK depicted):



The Building Regulations 2010 (England and Wales) (as amended)

| | | |
|--|---|--|
| Requirement: Comment: | A1 | Loading The systems can sustain and transmit wind loads to the substrate wall. See sections 7.1 to 7.12 of this Certificate. |
| Requirement: Comment: | B4(1) | External fire spread The systems are restricted by this Requirement. See sections 8.1 to 8.3 of this Certificate. |
| Requirement: Comment: | C2(b) | Resistance to moisture The systems can provide a degree of protection against rain ingress. See section 10.1 of this Certificate. |
| Requirement: Comment: | C2(c) | Resistance to moisture The systems can contribute to minimising the risk of interstitial and surface condensation. See sections 11.1, 11.2 and 11.4 of this Certificate. |
| Requirement: Comment: | L1(a)(i) | Conservation of fuel and power The systems can contribute to satisfying this Requirement. See sections 6.2 and 6.3 of this Certificate. |
| Regulation: Regulation: Comment: | 7 7(1) | Materials and workmanship (applicable to Wales only) Materials and workmanship (applicable to England only) The systems are acceptable. See section 13.1 and the <i>Installation</i> part of this Certificate. |
| Regulation: Comment: | 7(2) | Materials and workmanship (applicable to England only) The systems are restricted by this Regulation. See sections 8.1 to 8.3 of this Certificate. |
| Regulation: Regulation: Regulation: Regulation: Comment: | 26 26A 26A 26B | CO₂ emission rates for new buildings Fabric energy efficiency rates for new dwellings (applicable to England only) Primary energy consumption rates for new buildings (applicable to Wales only) Fabric performance values for new dwellings (applicable to Wales only) The systems can contribute to satisfying these Regulations. See sections 6.2 and 6.3 of this Certificate. |



The Building (Scotland) Regulations 2004 (as amended)

| | | |
|---|------------------------|--|
| Regulation: Comment: | 8(1)(2) | Durability, workmanship and fitness of materials The systems can contribute to a construction satisfying this Regulation. See sections 12 and 13.1 and the <i>Installation</i> part of this Certificate. |
| Regulation: Standard: Comment: | 9 1.1 | Building standards applicable to construction Structure The systems can sustain and transmit wind loads to the substrate wall. See sections 7.1 to 7.12 of this Certificate. |

| | | |
|--------------------|-----------|---|
| Standard: | 2.6 | Spread to neighbouring buildings |
| Comment: | | The systems are restricted by this Standard, with reference to clauses 2.6.4 ⁽¹⁾⁽²⁾ , 2.6.5 ⁽¹⁾ and 2.6.6 ⁽²⁾ . See sections 8.1, 8.2, 8.4 and 8.5 of this Certificate. |
| Standard: | 2.7 | Spread on external walls |
| Comment: | | The systems are restricted by this Standard, with reference to clauses 2.7.1 ⁽¹⁾⁽²⁾ and 2.7.2 ⁽²⁾ . See sections 8.1, 8.2, 8.4 and 8.5 of this Certificate. |
| Standard: | 3.10 | Precipitation |
| Comment: | | The systems can contribute to a construction satisfying this Standard, with reference to clauses 3.10.1 ⁽¹⁾⁽²⁾ and 3.10.2 ⁽¹⁾⁽²⁾ . See section 10.1 of this Certificate. |
| Standard: | 3.15 | Condensation |
| Comment: | | The systems can contribute to satisfying this Standard, with reference to clauses 3.15.1 ⁽¹⁾⁽²⁾ , 3.15.4 ⁽¹⁾⁽²⁾ and 3.15.5 ⁽¹⁾⁽²⁾ . See sections 11.3 and 11.4 of this Certificate |
| Standard: | 6.1(b) | Carbon dioxide emissions |
| Standard: | 6.2 | Building insulation envelope |
| Comment: | | The systems can contribute to satisfying these Standards, with reference to clauses (or parts of) 6.1.1 ⁽¹⁾ , 6.1.2 ⁽¹⁾⁽²⁾ , 6.1.3 ⁽¹⁾⁽²⁾ , 6.1.6 ⁽¹⁾ , 6.1.10 ⁽²⁾ , 6.2.1 ⁽¹⁾⁽²⁾ , 6.2.3 ⁽¹⁾ , 6.2.4 ⁽²⁾ , 6.2.5 ⁽²⁾ , 6.2.6 ⁽¹⁾ , 6.2.7 ⁽¹⁾ , 6.2.8 ⁽²⁾ , 6.2.9 ⁽¹⁾⁽²⁾ , 6.2.10 ⁽¹⁾ , 6.2.11 ⁽¹⁾ , 6.2.12 ⁽²⁾ and 6.2.13 ⁽¹⁾⁽²⁾ . See sections 6.2 and 6.3 of this Certificate. |
| Standard: | 7.1(a)(b) | Statement of sustainability |
| Comment: | | The systems can contribute to satisfying the relevant requirements of Regulation 9, Standards 1 to 6, and therefore will contribute to a construction meeting the bronze level of sustainability as defined in this Standard. In addition, the systems can contribute to a construction meeting a higher level of sustainability as defined in this Standard with reference to clauses 7.1.4 ⁽¹⁾⁽²⁾ [Aspect 1 ⁽¹⁾⁽²⁾ and 2 ⁽¹⁾], 7.1.6 ⁽¹⁾⁽²⁾ [Aspect 1 ⁽¹⁾⁽²⁾ and 2 ⁽¹⁾] and 7.1.7 ⁽¹⁾⁽²⁾ [Aspect 1 ⁽¹⁾⁽²⁾]. See section 6.2 of this Certificate. |
| Regulation: | 12 | Building standards applicable to conversions |
| Comment: | | All comments given for the systems under Regulation 9, Standards 1 to 6, also apply to this Regulation, with reference to clause 0.12.1 ⁽¹⁾⁽²⁾ and Schedule 6 ⁽¹⁾⁽²⁾ . |

(1) Technical Handbook (Domestic).
(2) Technical Handbook (Non-Domestic).



The Building Regulations (Northern Ireland) 2012 (as amended)

| | | |
|--------------------|--------------|---|
| Regulation: | 23 | Fitness of materials and workmanship |
| Comment: | | The systems are acceptable. See section 13.1 and the <i>Installation</i> part of this Certificate. |
| Regulation: | 28(b) | Resistance to moisture and weather |
| Comment: | | The systems provide a degree of protection against rain ingress. See section 10.1 of this Certificate. |
| Regulation: | 29 | Condensation |
| Comment: | | The systems can contribute to minimising the risk of interstitial condensation. See section 11.4 of this Certificate. |
| Regulation: | 30 | Stability |
| Comment: | | The systems can sustain and transmit wind loads to the substrate wall. See sections 7.1 to 7.12 of this Certificate. |
| Regulation: | 36(a) | External fire spread |
| Comment: | | The systems are restricted by this Regulation. See sections 8.1 to 8.3 of this Certificate. |

| | | |
|--------------------|---|--|
| Regulation: | 39(a)(i) | Conservation measures |
| Regulation: | 40 | Target carbon dioxide emission rate |
| Comment: | The systems can contribute to satisfying these Regulations. See sections 6.2 and 6.3 of this Certificate. | |

Construction (Design and Management) Regulations 2015 Construction (Design and Management) Regulations (Northern Ireland) 2016

Information in this Certificate may assist the client, designer (including Principal Designer) and contractor (including Principal Contractor) to address their obligations under these Regulations.

See sections: 3 *Delivery and site handling* (3.2 and 3.4) of this Certificate.

Additional Information

NHBC Standards 2018

In the opinion of the BBA, Fassatherm Bonded EPS External Wall Insulation Systems, if installed, used and maintained in accordance with this Certificate, can satisfy or contribute to satisfying the relevant requirements in relation to *NHBC Standards*⁽¹⁾, Part 6 *Superstructure (excluding roofs)*, Chapter 6.9 *Curtain walling and cladding*.

(1) There is a general requirement in *NHBC Standards*, Chapter 6.9, for fire-retardant-treated insulation to be used in accordance with BS EN 13163 : 2012.

Technical Specification

1 Description

1.1 Fassatherm Bonded EPS External Wall Insulation Systems comprise grey and white EPS insulation boards that are adhesively fixed to the substrate wall, with supplementary mechanical fixings. After the boards have been secured to the wall, basecoat (prepared as described in section 1.2) is trowel-applied to the required thickness, and the reinforcing mesh is applied and fully embedded. After the reinforced basecoat has cured, primer is applied followed by the render finish.

1.2 The systems comprise:

Adhesives

- a range of cement-based adhesives, supplied as powder to which clean water is added, and which should cover at least 50% of the bonded area of the board. The range comprises
 - Fassatherm A50 Adhesive — requiring the addition of approximately 5 litres of clean water per 25 kg of adhesive, applied to a coverage of 3 to 5 kg·m⁻²
 - Fassatherm A96 Adhesive — requiring the addition of approximately 6.5 litres of clean water per 25 kg of adhesive, applied to a coverage of 2.2 to 3.5 kg·m⁻²
 - Fassatherm AL88 Adhesive — requiring the addition of approximately 8 litres of clean water per 25 kg of adhesive, applied to a coverage of 2.2 to 3.5 kg·m⁻²

Insulation

- white and graphite-enhanced (grey) EPS insulation boards — 1200 by 600 mm, in a range of thicknesses between 30 and 300⁽¹⁾ mm, with a nominal density of 15 kg·m⁻³ for white EPS 70, 17 kg·m⁻³ for grey EPS 70 and 20 kg·m⁻³ for grey EPS 100, a minimum compressive strength of 70 or 100 kN·m⁻² and a tensile strength perpendicular to the faces of 100 kN·mm⁻². Boards are manufactured to comply with BS EN 13163 : 2012 and are classified as Euroclass E in accordance with BS EN 13501-1 : 2007

(1) Thicknesses less than 60 mm are for use as reveal insulation.

Fixings (supplementary)

- mechanical fixings — anchors with adequate length to suit the substrate and insulation thickness and selected from

- EJOT H1-ECO (Combi Fix) — high density polyethylene (HDPE) with electro-galvanized pins and a polyamide, PA GF 50 mounting plug
- EJOT STR U (Top Fix) — HDPE with stainless steel or electro-galvanized screws

Basecoats

- Fassatherm A50 Basecoat — a cement-based powder requiring the addition of approximately 5 litres of clean water per 25 kg of basecoat. Applied to a thickness of between 3 and 5 mm, for use with any render finish, to a coverage of approximately 5 to 6 kg·m⁻²
- Fassatherm A96 Basecoat — a cement-based powder requiring the addition of approximately 6.5 litres of clean water per 25 kg of basecoat. Applied to a thickness of between 4 and 6 mm, for use with any render finish, to a coverage of approximately 6 to 7 kg·m⁻²
- Fassatherm AL88 Basecoat — a cement-based powder requiring the addition of approximately 8 litres of clean water per 25 kg of basecoat. Applied to a thickness of between 4 and 6 mm, for use with Fassatherm RTA 549 render finish only, to a coverage of approximately 5 to 6 kg·m⁻²

Reinforcement

- Fassanet 160 — 1.0 m wide alkali-resistant glassfibre mesh, with a nominal weight of 155 g·m⁻² and mesh size of 3.8 by 4.1 mm

Primers

- Fassatherm FA 249 — liquid acrylic primer to which water is added, for use with Fassatherm RTA 549 render finish
- Fassatherm FS 412 — liquid silicone primer to which water is added, for use with Fassatherm RSR 421 render finish
- Fassatherm F328 — liquid silicate primer to which water is added, for use with Fassatherm R336 render finish
- Fassatherm FX 526 — liquid acrylic/siloxane primer to which water is added, for use with Fassatherm RX 561 render finish

Render finishes

- Fassatherm RTA 549 — an acrylic render available in a range of colours, with 1.0, 1.5, 2.0 and 3.0 mm grain sizes⁽¹⁾, and a coverage of 2 to 4 kg·m⁻²
- Fassatherm RSR 421 — a silicone render available in a range of colours, with 1.0, 1.5, 2.0 and 3.0 mm grain sizes⁽¹⁾, and a coverage of 2 to 4 kg·m⁻²
- Fassatherm R336 — a silicate render available in a range of colours, with 1.0, 1.5, 2.0 and 3.0 mm grain sizes⁽¹⁾, and a coverage of 2 to 4 kg·m⁻²
- Fassatherm RX 561 — an acrylic/siloxane render available in a range of colours, with 1.0, 1.5, 2.0 and 3.0 mm grain sizes⁽¹⁾, and a coverage of 2 to 4 kg·m⁻².

(1) Thickness is regulated by the grain size.

Figure 1 Fassatherm Bonded EPS External Wall Insulation Systems

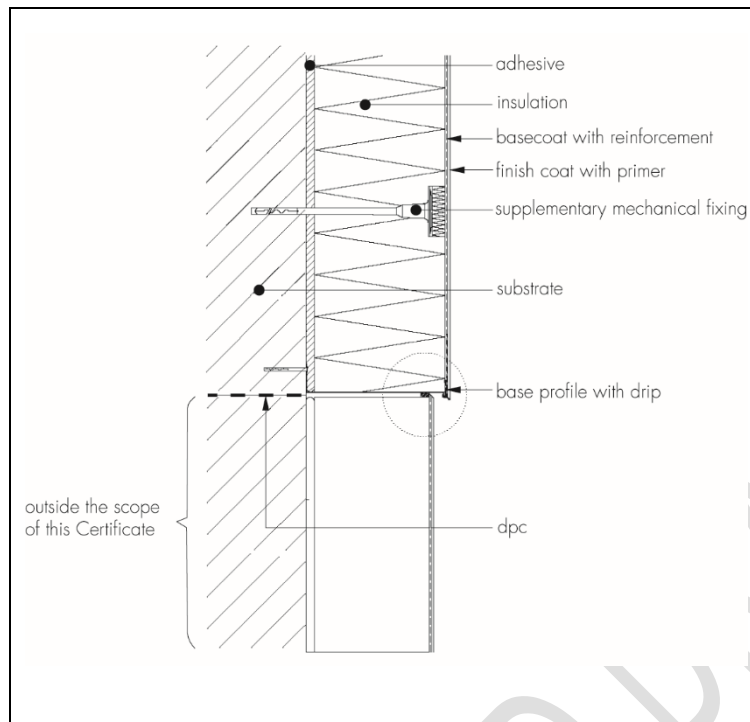

1.3 Ancillary materials used with the systems are a range of aluminium or PVC-U profiles, comprising:

- starter/base profile
- edge, corner and render stop profiles
- connector profile and fixings.

1.4 Ancillary materials also used with the systems, but outside the scope of this Certificate, are:

- algal and fungal wash
- expanding tape — polyurethane soft foam tape for sealing around window sills
- silicone sealant
- extruded polystyrene (XPS) insulation boards [under the damp-proof course (dpc) level].

2 Manufacture

2.1 The systems components are manufactured by the Certificate holder or bought in from suppliers, to an agreed specification.

2.2 As part of the assessment and ongoing surveillance of product quality, the BBA has:

- agreed with the manufacturer the quality control procedures and product testing to be undertaken
- assessed and agreed the quality control operated over batches of incoming materials
- monitored the production process and verified that it is in accordance with the documented process
- evaluated the process for management of nonconformities
- checked that equipment has been properly tested and calibrated
- undertaken to carry out the above measures on a regular basis through a surveillance process, to verify that the specifications and quality control operated by the manufacturer are being maintained.

2.3 The management system of Fassa S.r.l. has been assessed and registered as meeting the requirements of BS EN ISO 9001 : 2015 by IQNet (Certificate 09278).

3 Delivery and site handling

3.1 The boards are delivered in sealed packs, with the product identification and manufacturer's batch numbers.

3.2 The other components are delivered in the quantities and packaging listed in Table 1. Each package carries the product identification and manufacturer's batch number.

Table 1 Component Supply details

| Component | Quantity and packaging |
|------------------------------------|-------------------------------|
| Fassatherm adhesives and basecoats | 25 kg bag |
| Supplementary mechanical fixings | Boxed by manufacturer |
| Reinforcing mesh | 1 m wide rolls x 50 m length |
| Fassatherm primers | 5 or 16 litre tubs |
| Fassatherm render finishes | 25 kg tubs |

3.3 The insulation boards should be stored on a firm, clean, level base, off the ground and under cover until required for use. Care must be taken when handling the insulation to avoid damage.

3.4 The boards should be protected from prolonged exposure to sunlight, either by storing opened packs under cover or re-covering with opaque polythene sheeting. The boards should not be exposed to open flame or other ignition sources.

3.5 Care must be taken when handling the boards to avoid contact with solvents or materials containing volatile organic components.

3.6 The powder adhesives, primers and render finishes must be stored in tightly closed original packaging, in cool dry conditions, off the ground, and protected from moisture, excessive heat and frost at all times. Contaminated materials should be discarded.

Assessment and Technical Investigations

The following is a summary of the assessment and technical investigations carried out on Fassatherm Bonded EPS External Wall Insulation Systems.

Design Considerations

4 General

4.1 Fassatherm Bonded EPS External Wall Insulation Systems, when installed in accordance with this Certificate, are satisfactory for use in reducing the thermal transmittance (U value) of external masonry or concrete walls of new and existing buildings. It is essential that the detailing techniques specified in this Certificate are carried out to a high standard if the ingress of water into the insulation is to be avoided and the full thermal benefit obtained from treatment with the system (eg the insulation must be protected by an overhang, and window sills should be designed and installed so as to direct water away from the building).

4.2 For improved thermal/carbon-emissions performance of the structure, the designer should consider additional/alternative fabric and/or services measures.

4.3 The systems are for application to the outside of external walls of masonry, normal weight concrete, lightweight concrete, autoclaved concrete or no-fines concrete construction, on new or existing domestic and non-domestic buildings (with or without existing render) up to 18 metres in height (11 metres in Scotland). Prior to the installation of the systems, wall surfaces should comply with section 14.

4.4 New walls subject to the national Building Regulations should be constructed in accordance with the relevant recommendations of:

- BS EN 1992-1-1 : 2004 and its UK National Annex
- BS EN 1996-1-1 : 2005 and its UK National Annex
- BS EN 1996-2 : 2006 and its UK National Annex
- BS 8000-0 : 2014
- BS 8000-2.2 : 1990
- BS 8000-3 : 2001.

4.5 New walls not subject to regulatory requirements should also be built in accordance with the Standards identified in section 4.4.

4.6 Movement joints should be incorporated into the system in line with existing movement joints in the building structure and in accordance with the Certificate holder's recommendations for the specific installation.

4.7 The systems will improve the weather resistance of a wall and provide a decorative finish. However, for existing buildings, they should only be installed where there are no signs of dampness on the inner surface of the wall other than those caused solely by condensation.

4.8 The effect of the systems on the acoustic performance of a construction is outside the scope of this Certificate.

4.9 The fixing of sanitary pipework, plumbing, rainwater goods, satellite dishes, clothes lines, hanging baskets and similar items to the systems is outside the scope of this Certificate. See section 4.10.

4.10 External pipework and ducts should be removed before installation, and alterations made to underground drainage to accommodate repositioning of the pipework to the finished face of the systems. The Certificate holder can advise on suitable fixing methods, but these are outside the scope of this Certificate.

4.11 The designer should select a construction appropriate to the local wind-driven rain index, paying due regard to the design detailing, workmanship and materials to be used.

4.12 It is essential that the systems are installed and maintained in accordance with the conditions set out in this Certificate.

5 Practicability of installation

The systems should only be installed by specialised contractors who have successfully undergone training and registration by the Certificate holder (see section 15).

Note: The BBA operates a UKAS-accredited Approved Installer Scheme for external wall insulation (non-mandatory); details of approved installers are included on the BBA's website (www.bbacerts.co.uk).

6 Thermal performance

6.1 Calculations of thermal transmittance (U value) should be carried out in accordance with BS EN ISO 6946 : 2017 and BRE Report BR 443 : 2006, using the declared thermal conductivity values (λ_D) of the insulations given in Table 2.

Table 2 Thermal conductivity of the insulation (λ_D value)

| Insulation type | Thickness (mm) | Thermal conductivity ($W \cdot m^{-1} \cdot K^{-1}$) |
|------------------|----------------|--|
| EPS 70 white 038 | 30 to 300 | 0.038 |
| EPS 70 grey 032 | 30 to 300 | 0.032 |
| EPS 100 grey 030 | 30 to 300 | 0.030 |



6.2 The U value of a completed wall will depend on the insulation thickness, the type and number of fixings, and the insulating value of the substrate masonry and its internal finish. Calculated U values for sample constructions in accordance with the national Building Regulations are given in Table 3, and are based on the thermal conductivity given in Table 2.

Table 3 Insulation thickness required to achieve design U values⁽¹⁾⁽²⁾⁽³⁾ given in the national Building Regulations

| U value ⁽⁴⁾ (W·m ⁻² ·K ⁻¹) | Thickness of insulation (mm) | | | | | |
|---|---|--------------------|---------------------|---|--------------------|---------------------|
| | 215 mm brickwork, $\lambda = 0.56 \text{ W}\cdot\text{m}^{-1}\cdot\text{K}^{-1}$ | | | 200 mm dense blockwork, $\lambda = 1.75 \text{ W}\cdot\text{m}^{-1}\cdot\text{K}^{-1}$ | | |
| | EPS 70 white 038 | EPS 70 grey 032 | EPS 100 grey 030 | EPS 70 white 038 | EPS 70 grey 032 | EPS 100 grey 030 |
| 0.18 | 200 | 170 | 160 | 210 | 170 | 160 |
| 0.19 | 190 | 160 | 150 | 190 | 160 | 150 |
| 0.25 | 140 | 120 | 110 | 150 | 120 | 120 |
| 0.26 | 130 | 110 | 100 | 140 | 120 | 110 |
| 0.28 | 120 | 100 | 90 | 120 | 110 | 100 |
| 0.30 | 110 | 90 | 90 | 120 | 100 | 90 |
| 0.35 | 90 | 80 | 70 | 100 | 80 | 80 |

- (1) Wall construction inclusive of 13 mm plaster ($\lambda = 0.57 \text{ W}\cdot\text{m}^{-1}\cdot\text{K}^{-1}$), brickwork (protected) with 17.1% mortar or dense blockwork with 6.7% mortar ($\lambda = 0.88 \text{ W}\cdot\text{m}^{-1}\cdot\text{K}^{-1}$). Declared thermal conductivity of insulation values (λ_b) is as shown in Table 2. An adhesive layer, 5 mm thick with $\lambda = 0.43 \text{ W}\cdot\text{m}^{-1}\cdot\text{K}^{-1}$ covering 50% of the area is also included, and a board emissivity of 0.9, together with an external render thickness of 4 mm with $\lambda = 1 \text{ W}\cdot\text{m}^{-1}\cdot\text{K}^{-1}$.
- (2) Calculations based on a bonded system that included four polyethylene fixings per square metre with a point thermal transmittance (X_p) of $0.002 \text{ W}\cdot\text{K}^{-1}$ per pin. Use of other types of fixings should be calculated in accordance with BS EN ISO 6946 : 2017. A gap correction ($\Delta U''$) of zero is assumed.
- (3) Based upon an incremental insulation thickness of 10 mm.
- (4) When applying the maximum available insulation thickness, these walls can achieve U values from 0.10 to $0.13 \text{ W}\cdot\text{m}^{-2}\cdot\text{K}^{-1}$ depending on insulation and wall type.

6.3 Care must be taken in the overall design and construction of junctions with other elements and openings to minimise thermal bridges and air infiltration. Detailed guidance can be found in the documents supporting the national Building Regulations.

7 Strength and stability



7.1 The Certificate holder is ultimately responsible for the design of the system and it is the responsibility of the company installing the system to accurately follow the installation instructions (see also section 5 of this Certificate). The Certificate holder must also verify that a suitably experienced and qualified individual (with adequate professional indemnity) establishes that:

- the wind loads on the different zones of the building's elevation for the specific geographical location have been calculated correctly (see section 7.3)
- the system can adequately resist and safely transfer the calculated loads, accounting for all possible failure modes, to the substrate wall and supporting structure (see sections 7.3 to 7.6).

7.2 The substrate and supporting structure must be capable of transferring all additional loading due to the installation of the system to the ground in a satisfactory manner. The adequacy of the substrate and supporting structure must be verified by the person or party responsible for the global stability of the building to which the system is applied. Any defects should be made good prior to the system being installed.

7.3 The wind loads on the walls should be calculated, taking into account all relevant factors such as location and topography, in accordance with BS EN 1991-1-4 : 2005 and its UK National Annex. All of the factors affecting wind load on each elevation and specific zones of the building must be considered. In accordance with BS EN 1990 : 2002 and its UK National Annex, a partial factor of 1.5 must be applied to the calculated characteristic wind load to establish the design wind load to be resisted by the systems.

7.4 Installations correctly designed in accordance with this Certificate will safely accommodate the applied loads due to the self-weight of the systems, wind and impact.

7.5 Positive wind load is transferred to the substrate wall directly via compression through the render and insulation system.

7.6 Negative wind load is transferred to the substrate wall via⁽¹⁾⁽²⁾:

- the bond between the insulation and render system (see section 7.7)
- the tensile strength of the insulation (see section 7.8)
- the bond between the adhesive and the insulation interface⁽³⁾ (see section 7.9)
- the bond between the substrate and adhesive interface⁽³⁾ (see section 7.10).

(1) For adhesively fixed systems with supplementary mechanical fixings, the contribution of the fixings is not considered when calculating resistance to wind load.

(2) Further guidance is given in BBA Guidance Note 1, available on the BBA website (www.bbacerts.co.uk).

(3) The percentage of adhesive coverage should be considered.

7.7 The characteristic bond resistance between the insulation and render interface derived from test results was $80 \text{ kN}\cdot\text{m}^{-2}$. The design resistance of the bond between the insulation and render (N_{RD1}) should be taken as the characteristic bond resistance divided by a partial factor of 9.

7.8 The characteristic tensile resistance of the insulation material may be taken as $100 \text{ kN}\cdot\text{m}^{-2}$ and should be divided by a partial material factor of 2.5 to establish the ultimate design resistance of the insulation ($R_{d,t.ins}$).

7.9 The characteristic bond resistance between the adhesive and the insulation derived from test results was $30 \text{ kN}\cdot\text{m}^{-2(1)}$. The design resistance of the bond between the adhesive and insulation (N_{RD2}) should be taken as this value divided by a partial factor of 9.

(1) The minimum bonded surface area (A_{min}) should not be less than 50%.

7.10 The characteristic bond resistance between the substrate and the adhesive derived from test results was $250 \text{ kN}\cdot\text{m}^{-2(1)(2)(3)}$. The design resistance of the bond between the substrate and the adhesive (N_{RD3}) should be taken as the characteristic resistance divided by a partial factor of 9.

(1) The bond between the substrate and the adhesive from the test should have a minimum failure resistance of $250 \text{ kN}\cdot\text{m}^{-2}$ after the adhesive has fully cured and in dry conditions, in accordance with ETAG 004 : 2013. The minimum failure resistance value is based on a minimum 28 day curing time of the test sample.

(2) The results from tests carried out on site for the bond (while the adhesive is curing) between the substrate and the adhesive should be at least equal to $80 \text{ kN}\cdot\text{m}^{-2}$.

(3) The minimum bonded surface area (A_{min}) should not be less than 50%.

7.11 The number and spacing of the supplementary fixings should be determined by the Certificate holder. Provided the substrate wall is suitable and the supplementary fixings are covered by an appropriate ETA, the fixings will initially transfer the weight of the insulation system to the substrate wall while the adhesive is curing. However, since the characteristic pull-out resistance values are dependent on the substrate type, the fixing must be selected to suit the specific loads and substrate⁽¹⁾.

(1) To qualify as suitable data, the age and condition of the substrate must be equivalent to that used to establish the values in the ETA. If this is not the case, site-specific pull-out tests must be carried out.

7.12 The data obtained from sections 7.7 to 7.10 must be assessed against the design wind load and the following expression must be satisfied⁽¹⁾⁽²⁾ for safe design:

$$R_d \geq W_e$$

$$R_{d,b.ins/render} = A_r * N_{RD1}$$

$$R_{d,t.ins} = \text{characteristic tensile strength of insulation}/2.5$$

$$R_{d,b.adh/ins} = A_{min} * N_{RD2}$$

$$R_{d,b.sub/adh} = A_{min} * N_{RD3}$$

Where:

R_d is the design ultimate resistance ($\text{kN}\cdot\text{m}^{-2}$) taken as the minimum of $R_{d,b.ins/render}$, $R_{d,t.ins}$, $R_{d,b.adh/ins}$ and $R_{d,b.sub/adh}$

W_e is the applied ultimate wind load ($\text{kN}\cdot\text{m}^{-2}$)

$R_{d,b.ins/render}$ is the bond design resistance between the insulation and render ($\text{kN}\cdot\text{m}^{-2}$)

A_r is the reinforced basecoat bond area (based on % area covered)

| | |
|--------------------------|---|
| N _{RD1} | is the design adhesive bond resistance between the insulation and render based on tests (kN·m ⁻²) |
| R _{d,b.adh/ins} | is the bond design resistance between the insulation and adhesive (kN·m ⁻²) |
| A _{min} | is the minimum bonded surface area (based on % area covered) |
| N _{RD2} | is the design bond resistance between insulation and adhesive based on tests (kN·m ⁻²) |
| R _{d,b.sub/adh} | is the design bond resistance between the substrate and adhesive (kN·m ⁻²) |
| N _{RD3} | is the design bond resistance between the substrate and adhesive based on tests (kN·m ⁻²). |

- (1) If the minimum design resistance (R_d) calculated in sections 7.7 to 7.10 is less than the design wind pressure, the bonded surface area (A_{min}) should be increased.
- (2) If the minimum bonded surface area required to resist the design wind load is higher than 100%, the system would need to be mechanically fixed and therefore should not be installed: mechanically fixed system requirements have not been assessed with this Certificate.

Impact resistance

7.13 Hard body impact tests were carried out in accordance with ETAG 004 : 2013. The systems are suitable for use in the Use Categories up to and including those specified in Table 4 of this Certificate.

Table 4 System impact resistance

| Render finish | Use Category ⁽¹⁾ |
|--|-----------------------------|
| Fassatherm RTA 549 | I |
| Fassatherm RSR 421, Fassatherm R336, Fassatherm RX 561 | II |

(1) The Use Categories are defined in ETAG 004 : 2013 as:

- Category I — a zone readily accessible at ground level to the public and vulnerable to hard body impacts but not subjected to abnormally rough use
- Category II — a zone liable to impacts from thrown or kicked objects, but in public locations where the height of the system will limit the size of the impact; or at lower levels where access to the building is primarily to those with some incentive to exercise care
- Category III — a zone not likely to be damaged by normal impacts caused by people or by thrown or kicked objects.

8 Behaviour in relation to fire



8.1 The reaction to fire classification for the systems is B-s2, d0 in accordance with BS EN 13501-1 : 2007⁽¹⁾.

(1) Istituto per le Tecnologie della Costruzione. 15 October 2012. Report number: 5483/RC/12.

8.2 The fire classification applies to the full range of thicknesses and colours covered by this Certificate.



8.3 For all buildings in England and Wales and Northern Ireland, the systems are considered suitable for use on, or at any distance from, the boundary and the systems are restricted for use in buildings up to 18 metres in height.



8.4 In Scotland, the systems are not classified as non-combustible and may be used on buildings more than 1 m from a boundary and, on houses, 1 m or less from a boundary. With minor exceptions, the systems should be included in calculations of unprotected area, except on houses where the external wall behind has the appropriate fire resistance.

8.5 In Scotland, the systems should not be used on any building with a storey more than 11 m above the ground, or on any entertainment or assembly building with a total storey area more than 500 m², or on any hospital or residential care building with a total storey area more than 200 m².

8.6 For application to second storey walls and above, it is recommended that the designer considers at least one stainless steel fixing per square metre, and fire barriers in line with compartment walls and floors, as advised in BRE Report BR 135 : 2013 (see Figure 2 of this Certificate).

Figure 2 Fire barrier details

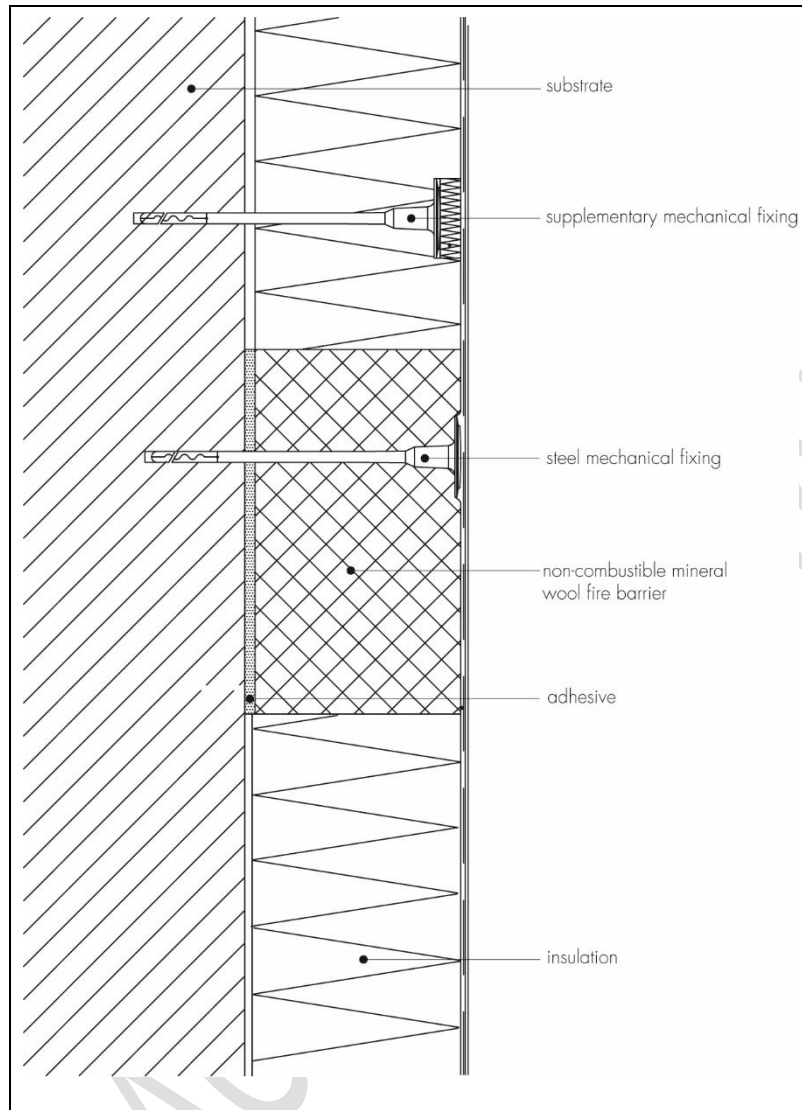

9 Proximity of flues and appliances

When the systems are installed in close proximity to certain flue pipes, the relevant provisions of the national Building Regulations should be satisfied:

England and Wales — Approved Document J

Scotland — Mandatory Standard 3.19, clause 3.19.4⁽¹⁾⁽²⁾

(1) Technical Handbook (Domestic).

(2) Technical Handbook (Non-Domestic).

Northern Ireland — Technical Booklet L.

10 Water resistance



10.1 The systems will provide a degree of protection against water ingress. However, care should be taken to ensure that walls are adequately watertight prior to application of the systems. The systems must only be installed where there is no sign of dampness on the inner surface of the substrate other than that caused solely by condensation.

10.2 Designers and installers should take particular care in detailing around openings, penetrations and movement joints to minimise the risk of water ingress.

10.3 The guidance given in BRE Report BR 262 : 2002 should be followed in connection with the watertightness of solid wall constructions. The designer should select a construction appropriate to the local wind-driven rain index, paying due regard to the design detailing, workmanship and materials to be used.

10.4 At the tops of walls, the systems should be protected by an adequate coping, overhang or other detail designed for use with these types of systems (see section 16).

11 Risk of condensation



11.1 Designers must ensure that an appropriate condensation risk analysis has been carried out for all parts of the construction, including openings and penetrations at junctions between the systems and windows, to minimise the risk of condensation. The recommendations of BS 5250 : 2011 should be followed.

Surface condensation



11.2 Walls will adequately limit the risk of surface condensation when the thermal transmittance (U value) does not exceed $0.7 \text{ W}\cdot\text{m}^{-2}\cdot\text{K}^{-1}$ at any point and the junctions with other elements and openings comply with section 6.3.



11.3 Walls will adequately limit the risk of surface condensation when the thermal transmittance (U value) does not exceed $1.2 \text{ W}\cdot\text{m}^{-2}\cdot\text{K}^{-1}$ at any point. Guidance may be obtained from BS 5250 : 2011 section 4 and Annex G, and BRE Report BR 262 : 2002.

Interstitial condensation



11.4 Walls incorporating the systems will adequately limit the risk of interstitial condensation when they are designed and constructed in accordance with BS 5250 : 2011 section 4, Annexes D and G and Table 6.

11.5 The equivalent air layer thickness (s_a) (for the render systems) and the water vapour resistance (μ) factor (for the boards) are shown in Table 5 of this Certificate.

Table 5 Water vapour resistance factor and equivalent air layer thickness

| | (s _d) (m) | (μ) |
|---|--------------------------|-------------------------|
| EPS — insulation thickness 30 to 300 mm (white and grey EPS 70) | — | 20 to 40 ⁽¹⁾ |
| EPS — insulation thickness 30 to 300 mm (grey EPS 100) | — | 30 to 70 ⁽¹⁾ |
| Render system: | | |
| Fassatherm A50 Basecoat⁽²⁾ + primer + render finish (specific particle size), as indicated below | | |
| Fassatherm FA 249 + Fassatherm RTA 549 (particle size 1.0 mm) | 0.445 | — |
| Fassatherm FA 249 + Fassatherm RTA 549 (particle size 1.5 mm) | 0.461 | — |
| Fassatherm FA 249 + Fassatherm RTA 549 (particle size 2.0 mm) | 0.537 | — |
| Fassatherm FA 249 + Fassatherm RTA 549 (particle size 3.0 mm) | 0.561 | — |
| Fassatherm FS 412 + Fassatherm RSR 421 (particle size 1.0 mm) | 0.406 | — |
| Fassatherm FS 412 + Fassatherm RSR 421 (particle size 1.5 mm) | 0.433 | — |
| Fassatherm FS 412 + Fassatherm RSR 421 (particle size 2.0 mm) | 0.434 | — |
| Fassatherm FS 412 + Fassatherm RSR 421 (particle size 3.0 mm) | 0.508 | — |
| Fassatherm F238 + Fassatherm R336 (particle size 1.0 mm) | 0.326 | — |
| Fassatherm FX 526 + Fassatherm RX 561 (particle size 1.0 mm) | 0.510 | — |
| Fassatherm FX 526 + Fassatherm RX 561 (particle size 3.0 mm) | 0.7 | — |
| Render system: | | |
| Fassatherm A96 Basecoat⁽³⁾ + primer + render finish (specific particle size), as indicated below | | |
| Fassatherm FA 249 + Fassatherm RTA 549 (particle size 1.0 mm) | 0.299 | — |
| Fassatherm FA 249 + Fassatherm RTA 549 (particle size 1.5 mm) | 0.333 | — |
| Fassatherm FA 249 + Fassatherm RTA 549 (particle size 2.0 mm) | 0.416 | — |
| Fassatherm FA 249 + Fassatherm RTA 549 (particle size 3.0 mm) | 0.421 | — |
| Fassatherm FS 412 + Fassatherm RSR 421 (particle size 1.0 mm) | 0.290 | — |
| Fassatherm FS 412 + Fassatherm RSR 421 (particle size 1.5 mm) | 0.281 | — |
| Fassatherm FS 412 + Fassatherm RSR 421 (particle size 2.0 mm) | 0.325 | — |
| Fassatherm FS 412 + Fassatherm RSR 421 (particle size 3.0 mm) | 0.410 | — |
| Fassatherm F238 + Fassatherm R336 (particle size 1.0 mm) | 0.215 | — |
| Fassatherm FX 526 + Fassatherm RX 561 (particle size 1.0 mm) | 0.510 | — |
| Fassatherm FX 526 + Fassatherm RX 561 (particle size 3.0 mm) | 0.480 | — |
| Render system: | | |
| Fassatherm AL88 Basecoat⁽³⁾ + primer + render finish (specific particle size), as indicated below | | |
| Fassatherm FA 249 + Fassatherm RTA 549 (particle size 1.0 mm) | 0.293 | — |
| Fassatherm FA 249 + Fassatherm RTA 549 (particle size 1.5 mm) | 0.311 | — |
| Fassatherm FA 249 + Fassatherm RTA 549 (particle size 2.0 mm) | 0.395 | — |
| Fassatherm FA 249 + Fassatherm RTA 549 (particle size 3.0 mm) | 0.411 | — |
| Fassatherm FX 526 + Fassatherm RX 561 (particle size 3.0 mm) | 0.5 | — |

(1) It is recommended that the lower figure is used when assessing the interstitial condensation risk.

(2) Applied to a thickness of 3 mm.

(3) Applied to a thickness of 4 mm.

12 Maintenance and repair



12.1 Regular checks should be made on the installed systems, including:

- an initial inspection after 12 months and subsequently every five years
- visual inspection of the render for signs of damage. Cracks in the render exceeding 0.2 mm must be repaired
- examination of the sealant around openings and service entry points
- visual inspection of architectural details designed to shed water to confirm that they are performing properly
- visual inspection to ensure that water is not leaking from external downpipes or gutters; such leakage could penetrate the rendering
- necessary repairs effected immediately and the sealant joints at window and door frames replaced at regular intervals
- maintenance schedules, which should include the replacement and resealing of joints, for example, between the insulation systems and window and door frame.

12.2 Damaged areas must be repaired using the appropriate components and procedures detailed in the Certificate holder's installation instructions, and in accordance with BS EN 13914-1 : 2016.

13 Durability



13.1 The systems will have a service life of at least 30 years provided any damage to the surface finish is repaired immediately and regular maintenance is undertaken, as described in section 12.

13.2 Renders containing Portland cement may be subject to lime bloom. The occurrence of this may be reduced by avoiding application in adverse weather conditions. The effect is transient and is less noticeable on lighter colours.

13.3 The render may become discoloured with time, the rate depending on the initial colour, the degree of exposure and atmospheric pollution, as well as the design and detailing of the wall. In common with traditional renders, discoloration by algae and lichens may occur in wet areas. The appearance may be restored by a suitable power wash or, if required, by over coating, provided the coating does not adversely affect the water vapour transmission or fire characteristics of the systems. The advice of the Certificate holder should be sought as to the suitability of a particular product.

Installation

14 Site survey and preliminary work

14.1 A pre-installation survey of the property must be carried out to determine suitability for treatment and the need for any necessary repairs to the building structure before application of the systems. A specification is prepared for each elevation of the building indicating:

- the position of beads
- detailing around windows and doors and at eaves
- dpc level
- exact position of expansion joints, if required
- areas where flexible sealants must be used
- any alterations to external plumbing
- the position of fire barriers.

14.2 The survey should include tests conducted on the walls of the building by the Certificate holder or their approved installers to determine the bond strength between the adhesive and the substrate, and be satisfied that the pull-out resistance of the proposed supplementary mechanical fixings from the substrate is adequate. An assessment and recommendation should be made on the minimum bond strength and type and number of fixings required to withstand the building's expected wind loading based on calculations using the test site data in accordance with section 7.

14.3 Surfaces should be sound, clean and free from loose material. The flatness of surfaces must be checked; this may be achieved using a straight edge spanning the storey height. Any excessive irregularities, ie greater than 10 mm in one metre, must be made good prior to installation to ensure that the boards are installed with a smooth, in-plane finished surface.

14.4 Where surfaces are covered with an existing render, it is essential that the bond between the background and the render is adequate. All loose areas should be hacked off and reinstated.

14.5 On existing buildings, purpose-made window sills must be fitted to extend beyond the finished face of the systems. New buildings should incorporate suitably deep sills.

14.6 In new buildings, internal wet work (eg screed or plastering) should be completed and allowed to dry prior to the application of the systems.

14.7 All modifications, such as provision for cavity barriers and fire stopping (see section 8), and necessary repairs to the building structure, must be completed before installation commences.

15 Approved installers

Application of the systems, within the context of this Certificate, must be carried out by installers approved by the Certificate holder. A Certificate holder approved installer is a company:

- employing operatives who have been trained and approved by the Certificate holder to install the systems
- which has undertaken to comply with the Certificate holder's application procedure, containing the requirement for each application team to include at least one member-operative trained by the Certificate holder
- subject to at least one inspection per annum by the Certificate holder to ensure suitable site practices are being employed. This may include unannounced site inspections.

16 Procedure

General

16.1 Installation of the systems must be carried out in accordance with the Certificate holder's current installation instructions and this Certificate.

16.2 Weather conditions should be monitored to ensure correct application and curing conditions. The systems should not be applied at temperatures below 5°C or above 30°C, if exposure to frost is likely or in damp/wet conditions, and the render must be protected from rapid drying.

16.3 The planarity of the substrate must be checked, and any protrusions exceeding 10 mm removed.

16.4 All rendering should be in accordance with the relevant recommendations of BS EN 13914-1 : 2016.

16.5 Before installation takes place, the building designer must confirm where items such as rainwater goods, satellite dishes, clothes lines and hanging baskets will be placed. The fixing points for these items must be specifically designated and built into the systems as the insulation is installed. This is outside the scope of this Certificate.

Positioning and securing insulation boards

16.6 The base profile is secured to the external wall above the dpc using mechanical fixings at a minimum of 300 mm centres. Profiles and expansion joints are fitted as specified.

16.7 The adhesive is mixed in a suitable container using potable water and a high power drill and mixer spiral to create a paste-like mortar, whilst ensuring there are no lumps in the mixed material. The boards are positioned on the starter track and bonded to the wall by applying the approved adhesive to the boards using the strip and dot method or full surface application. A circumferential strip of adhesive at least 5 to 10 cm wide is applied to the boards. Three evenly distributed patches of adhesive 5 to 10 cm in diameter are then applied to the boards so that an adhesive surface of at least 50% is achieved (see Figure 3). The insulation board should be immediately placed on the substrate and pressed into place.

Figure 3 Insulation boards — adhesive pattern

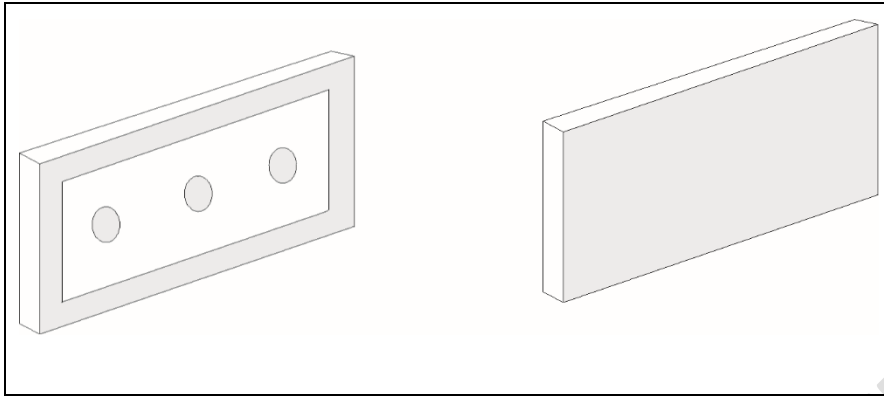

16.8 Subsequent rows of boards are positioned so that the vertical board joints are staggered and overlapped at the building corners.

16.9 Care must be taken to ensure that all board edges are butted tightly together, and alignment is checked as work proceeds. Gaps must be filled with strips of the insulation material.

16.10 A minimum of 4 mechanical fixings per square metre should be installed, unless otherwise specified in the project-specific design.

16.11 Details of supplementary mechanical fixings (including their arrangement in the boards) are specified in the project-specific design requirements based on pull-out test results, substrate type and wind loading data. Installation of mechanical fasteners must commence no earlier than 24 hours after the insulation boards have been adhesively fixed, and in any case after the adhesive has hardened.

16.12 The surface of the boards should be smooth without high spots or irregularities. Any high spots or irregularities should be removed by lightly planing with a rasp. After sufficient stabilisation of the installed insulation (normally 2 days in warm and dry conditions, or a maximum of one week in cold and damp conditions, during which time the insulation should be protected from exposure to extreme weather conditions to prevent degradation), the wall is ready for the application of the basecoat.

16.13 To fit around details such as doors and windows, boards may be cut with a sharp knife or a fine-tooth saw. Purpose-made window sills, seals and deflection channels, designed to prevent or manage water ingress and allow water to be shed clear of items bridging the cavity, should be fitted. The performance of these components is outside the scope of this Certificate.

16.14 At all locations where there is a risk of insulant exposure (eg window reveals or eaves), the systems must be protected, eg by an adequate overhang or by purpose-made sub-sills, seals or flashing.

16.15 Building corners, door and window heads and jambs are formed using corner profiles in accordance with the Certificate holder's instructions. Corner profiles are fixed to all building corners.

16.16 Installation continues until the whole wall is completely covered including, where appropriate, the building soffits.

Movement joints

16.17 Movement joints should be incorporated, where required. Existing structural expansion joints should be extended through to the surface of the systems (see Figure 4).

Figure 4 Movement joint detail

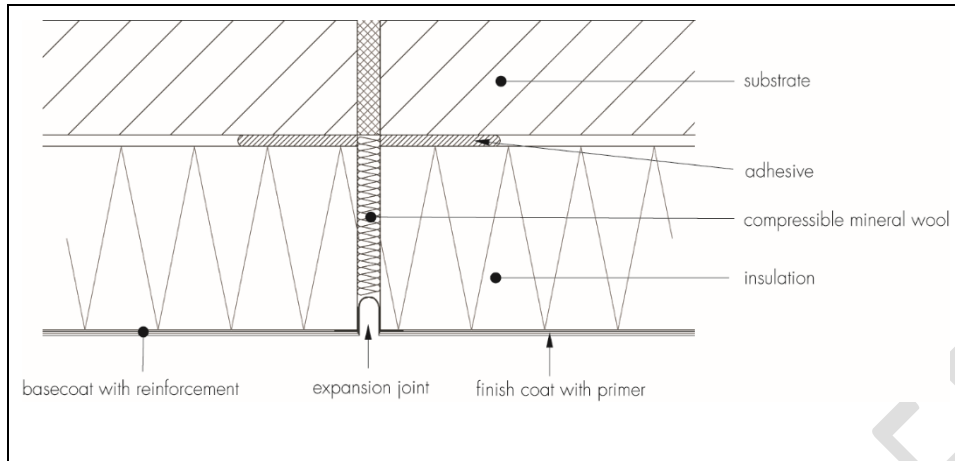

Basecoat and reinforcing mesh

16.18 The basecoat is prepared as described in section 16.7. The material is applied over the boards using a steel trowel, to a thickness of between 3 and 4 mm when using the Fassatherm A50 Basecoat, and 4 to 5 mm when using the Fassatherm A96 and Fassatherm AL88 Basecoats. The reinforcing mesh is applied and is immediately embedded into the basecoat, ensuring the mesh is overlapped at joints by a minimum coverage of 100 mm. Once the first coat has dried, a second coat of approximately 1 mm thickness is applied to obtain a smooth and uniform surface.

16.19 Additional pieces of reinforcing mesh are applied diagonally at the corners of openings to provide the necessary reinforcement in accordance with the Certificate holder's instructions (see Figure 5). Additional layers of reinforcing mesh may be applied to improve impact resistance.

Figure 5 Additional reinforcement at openings

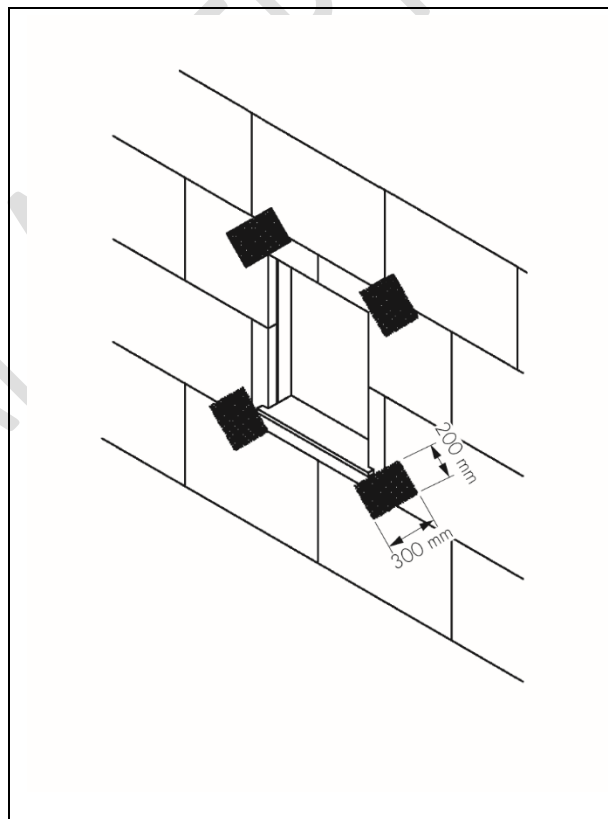

Rendering and finishing

16.20 Prior to the application of the render finish, the relevant seals are positioned and installed at all openings (eg windows and doors), overhanging eaves, gas and electric meter boxes, wall vents or where the render abuts any other building material or surface. This helps to reduce the risk of water ingress into the structure.

16.21 The basecoat must be allowed to dry/cure (for approximately 2 to 3 weeks) prior to the application of the primer/render finish. Prior to the application of the render finish, silicone sealant should be applied as required, as defined in the project-specific site package in accordance with the Certificate holder's instructions.

16.22 Primers (see section 1.1 for list of primers and their compatibility with the render finishes must be applied in accordance with the Certificate holder's instructions and allowed to dry for approximately 24 hours prior to the application of the render finish.

16.23 Render finishes are applied in accordance with the Certificate holder's instructions.

16.24 Care should be taken in the detailing of the systems around features such as openings, projections and at eaves (see Figures 6 to 9), to ensure adequate protection against water ingress and to limit the risk of water penetrating the systems.

Figure 6 Typical roof eaves detail

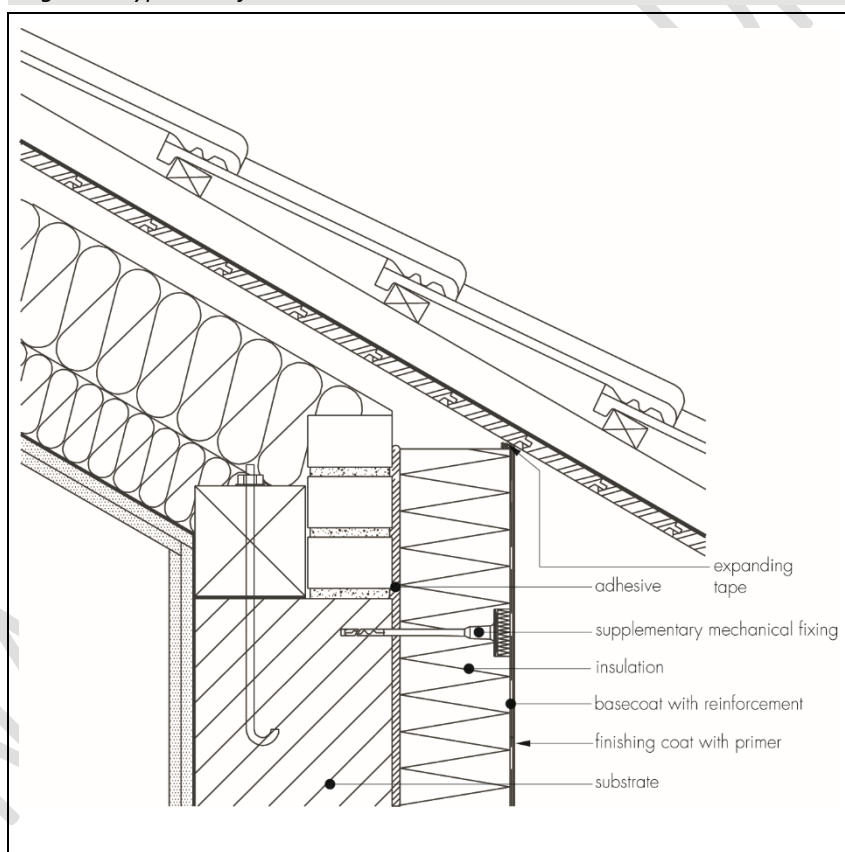

Figure 7 Window sill detail

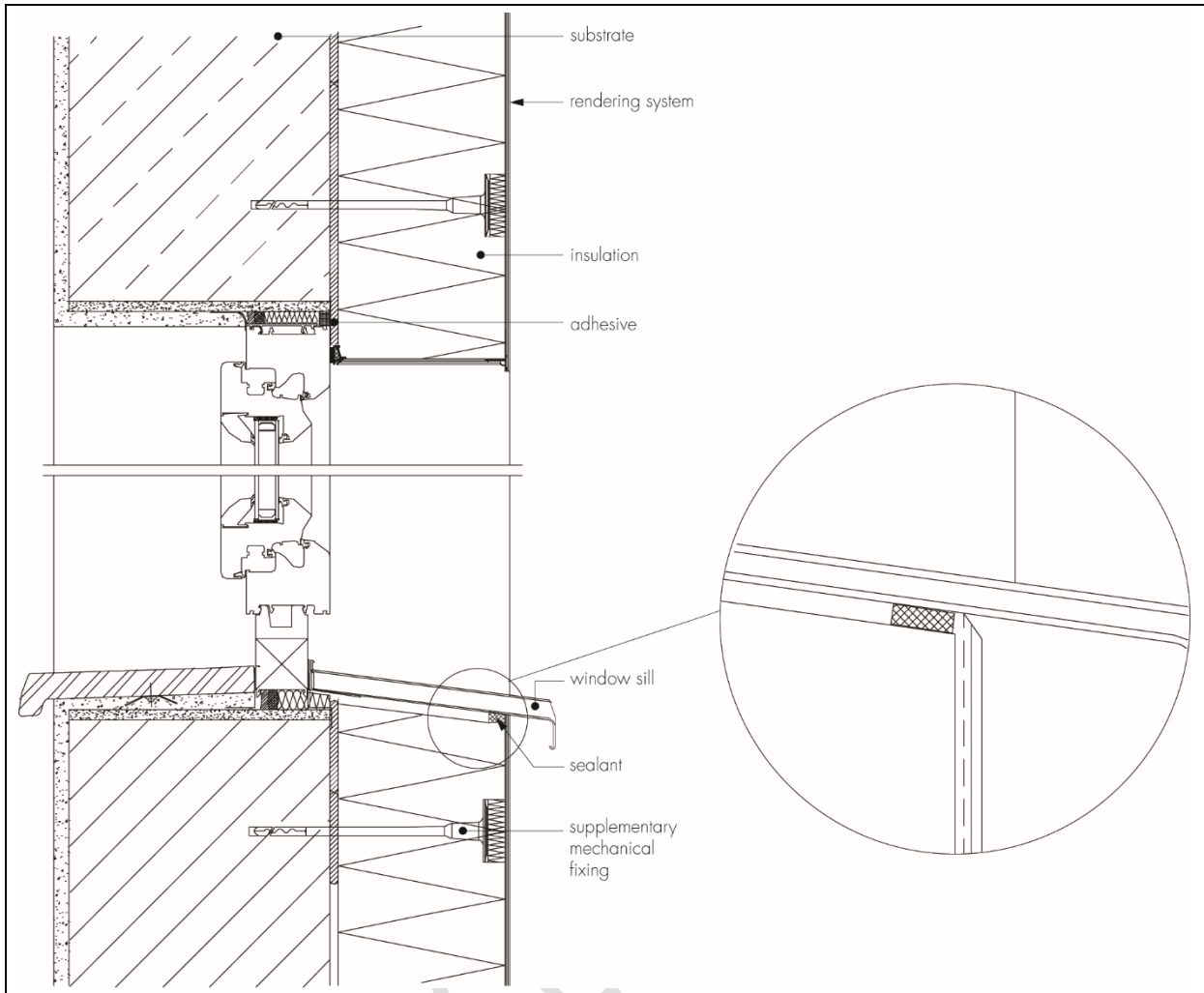

Figure 8 Window head detail

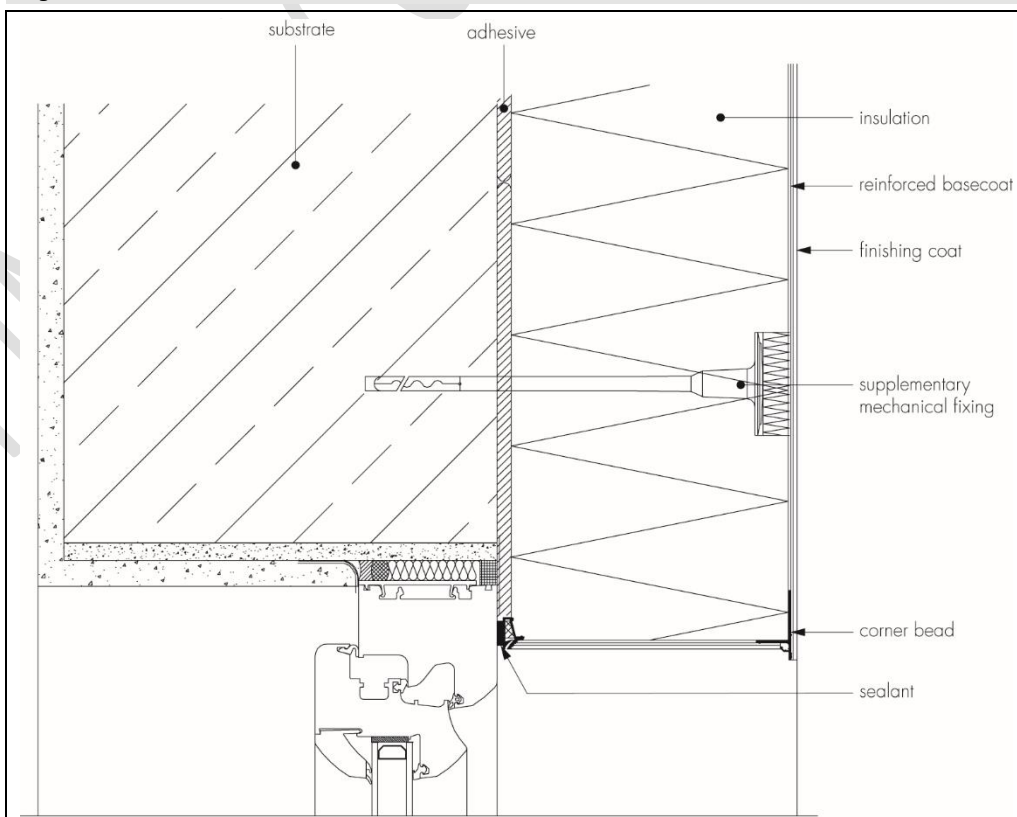
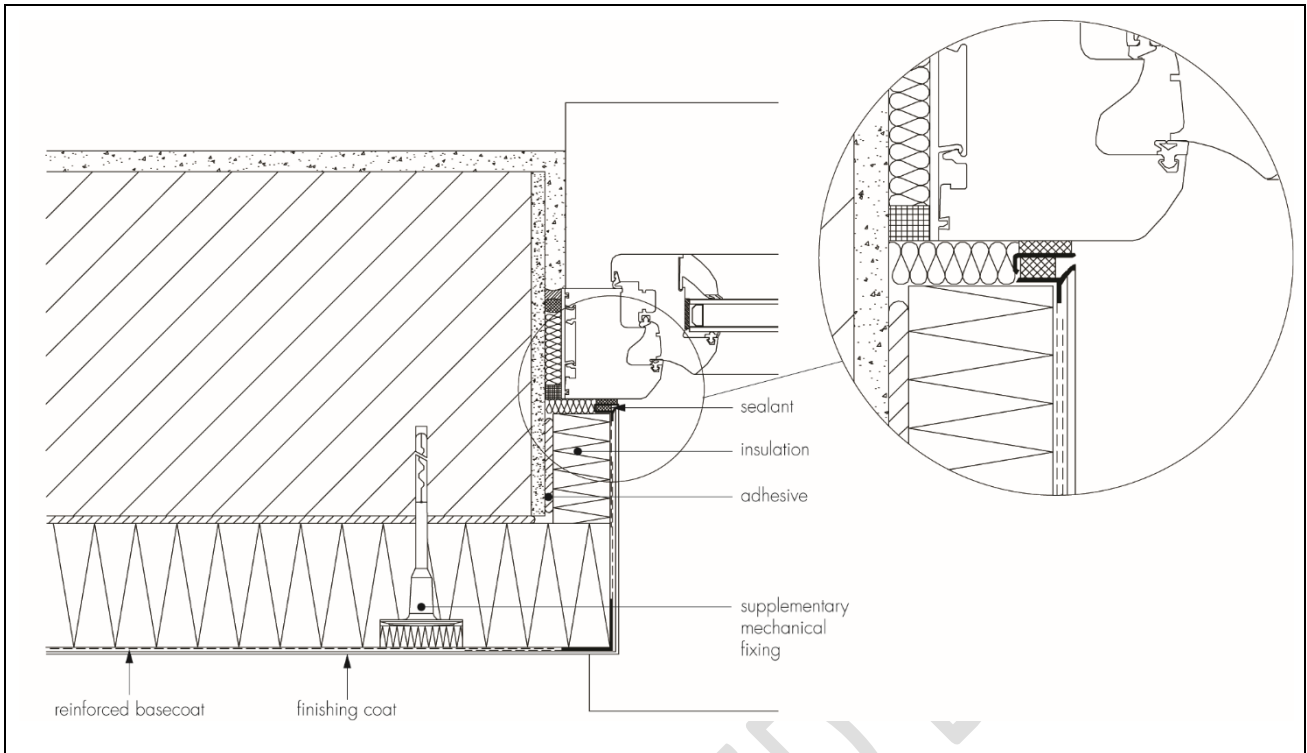

Figure 9 Insulated reveal detail



Technical Investigations

17 Tests

17.1 An examination was made of data relating to:

- component characterisation
- water vapour permeability
- water absorption
- bond strength
- reaction to fire
- pull-out strength of fixings
- durability of render finishes
- heat/spray cycling
- impact resistance.

17.2 The manufacturing process was evaluated, including the methods adopted for quality control, and details were obtained of the quality and composition of the materials used.

17.3 An assessment of the risk of interstitial condensation was undertaken.

17.4 The practicability of installation and the effectiveness of detailing techniques were examined.

Bibliography

BRE Report BR 135 : 2013 *Fire performance of external thermal insulation for walls of multistorey buildings*

BRE Report BR 262 : 2002 *Thermal insulation : avoiding risk*

BRE Report BR 443 : 2006 *Conventions for U-value calculations*

BS 5250 : 2011 + A1 : 2016 *Code of practice for control of condensation in buildings*

BS 8000-0 : 2014 *Workmanship on construction sites — Introduction and general principles*

BS 8000-2.2 : 1990 *Workmanship on building sites — Code of practice for concrete work — Sitework with in situ and precast concrete*

BS 8000-3 : 2001 *Workmanship on building sites — Code of practice for masonry*

BS EN 1990 : 2002 + A1 : 2005 *Eurocode — Basis of structural design*

BS EN 1991-1-4 : 2005 + A1 : 2010 *Eurocode 1 — Actions on structures — General actions — Wind actions*

NA to BS EN 1991-1-4 : 2005 + A1 : 2010 *UK National Annex to Eurocode 1 — Actions on structures — General actions — Wind actions*

BS EN 1992-1-1 : 2004 + A1 : 2014 *Eurocode 2 — Design of concrete structures — General rules and rules for buildings*

NA + A2 : 14 to BS EN 1992-1-1 : 2004 + A1 : 2014 *UK National Annex to Eurocode 2 — Design of concrete structures — General rules and rules for buildings*

BS EN 1996-1-1 : 2005 + A1 : 2012 *Eurocode 6 — Design of masonry structures — General rules for reinforced and unreinforced masonry structures*

NA to BS EN 1996-1-1 : 2005 + A1 : 2012 *UK National Annex to Eurocode 6 — Design of masonry structures — General rules for reinforced and unreinforced masonry structures*

BS EN 1996-2 : 2006 *Eurocode 6 — Design of masonry structures — Design considerations, selection of materials and execution of masonry*

NA to BS EN 1996-2 : 2006 *UK National Annex to Eurocode 6 — Design of masonry structures — Design considerations, selection of materials and execution of masonry*

BS EN 13163 : 2012 + A2 : 2016 *Thermal insulation products for buildings — Factory made products of expanded polystyrene (EPS) — Specification*

BS EN 13501-1 : 2007 + A1 : 2009 *Fire classification of construction products and building elements — Classification using test data from reaction to fire tests*

BS EN 13914-1 : 2016 *Design, preparation and application of external rendering and internal plastering — External rendering*

BS EN ISO 6946 : 2017 *Building components and building elements — Thermal resistance and thermal transmittance — Calculation method*

BS EN ISO 9001 : 2015 *Quality management systems — Requirements*

ETAG 004 : 2013 *Guideline for European Technical Approval of Plastic Anchors for fixing of External Thermal Composite Systems with Rendering*

18 Conditions

18.1 This Certificate:

- relates only to the product/system that is named and described on the front page
- is issued only to the company, firm, organisation or person named on the front page – no other company, firm, organisation or person may hold claim that this Certificate has been issued to them
- is valid only within the UK
- has to be read, considered and used as a whole document – it may be misleading and will be incomplete to be selective
- is copyright of the BBA
- is subject to English Law.

18.2 Publications, documents, specifications, legislation, regulations, standards and the like referenced in this Certificate are those that were current and/or deemed relevant by the BBA at the date of issue or reissue of this Certificate.

18.3 This Certificate will remain valid for an unlimited period provided that the product/system and its manufacture and/or fabrication, including all related and relevant parts and processes thereof:

- are maintained at or above the levels which have been assessed and found to be satisfactory by the BBA
- continue to be checked as and when deemed appropriate by the BBA under arrangements that it will determine
- are reviewed by the BBA as and when it considers appropriate.

18.4 The BBA has used due skill, care and diligence in preparing this Certificate, but no warranty is provided.

18.5 In issuing this Certificate the BBA is not responsible and is excluded from any liability to any company, firm, organisation or person, for any matters arising directly or indirectly from:

- the presence or absence of any patent, intellectual property or similar rights subsisting in the product/system or any other product/system
- the right of the Certificate holder to manufacture, supply, install, maintain or market the product/system
- actual installations of the product/system, including their nature, design, methods, performance, workmanship and maintenance
- any works and constructions in which the product/system is installed, including their nature, design, methods, performance, workmanship and maintenance
- any loss or damage, including personal injury, howsoever caused by the product/system, including its manufacture, supply, installation, use, maintenance and removal
- any claims by the manufacturer relating to CE marking.

18.6 Any information relating to the manufacture, supply, installation, use, maintenance and removal of this product/system which is contained or referred to in this Certificate is the minimum required to be met when the product/system is manufactured, supplied, installed, used, maintained and removed. It does not purport in any way to restate the requirements of the Health and Safety at Work etc. Act 1974, or of any other statutory, common law or other duty which may exist at the date of issue or reissue of this Certificate; nor is conformity with such information to be taken as satisfying the requirements of the 1974 Act or of any statutory, common law or other duty of care.